



EDINBURGH
INSTRUMENTS

PHOTOLUMINESCENCE SPECTROMETER

FLS1000



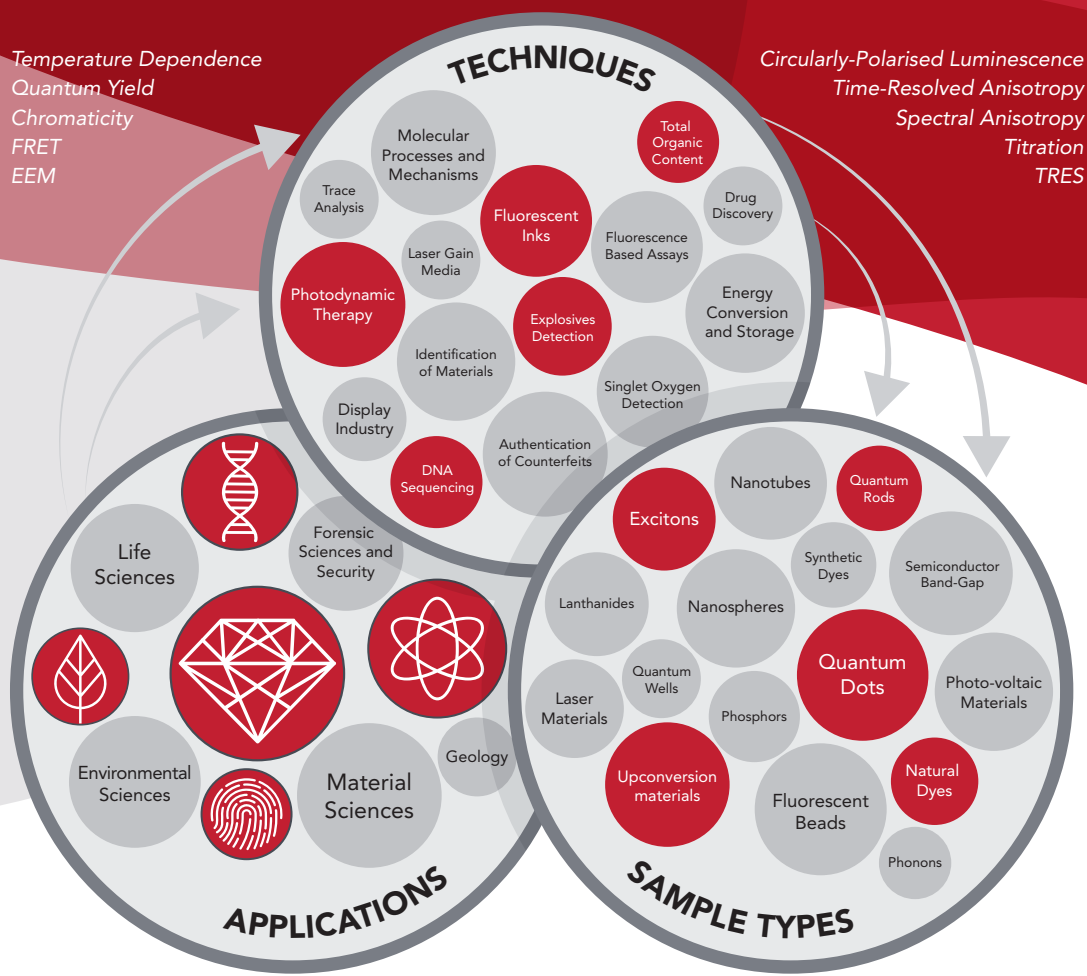

The FLS1000 is a state-of-the-art, modular photoluminescence spectrometer for the most demanding applications in Photophysics, Photochemistry, Material Sciences and Life Sciences.

The instrument sets the standards in both steady state and time-resolved spectroscopy: The system demonstrates unmatched sensitivity and can be configured for spectral measurements from the ultraviolet to the mid-infrared spectral range, and for lifetime measurements spanning time resolutions over 12 orders of magnitude from picoseconds to seconds.

- 4 The World's Most Sensitive Photoluminescence Spectrometer
- 8 The Industry Leading Photoluminescence Lifetime Spectrometer
- 12 Maps – Adding an Extra Dimension
- 16 FLS1000 Combined Steady State & Time-Resolved Photoluminescence Spectrometer
- 20 Sample Holders and Temperature Control
- 21 Configurations
- 22 Applications Overview
- 23 Technical Specifications

FLS1000

A NEW ERA IN PHOTOLUMINESCENCE

Faster Measurements

New Software

Higher Resolution

Increased Automation



STEADY STATE AND TIME-RESOLVED PHOTOLUMINESCENCE

- Modular construction for maximum flexibility and upgradability
- Industry leading sensitivity specification >35,000:1 (SQRT Method)
- Unrivalled spectral coverage from the deep UV to the MIR, 185 nm up to 5,500 nm
- Unmatched monochromator performance with "plug and play" triple-grating turrets, integrated filter wheel, 325 mm focal length and excellent stray light rejection
- Multiple light sources, detectors, single or double monochromators available
- Intuitive Fluoracle[®] software for all steady state and time-resolved measurements with standard and advanced data analysis options

PHOTON COUNTING - DETECTION AT THE QUANTUM LIMIT

Single photon counting is the most sensitive measurement technique in fluorescence and phosphorescence spectroscopy.

It is a digital technique from the start: Signals are detected at the quantum limit, noise pulses and background fluctuations are removed, light source instabilities and detector gain fluctuations are largely eliminated giving the most accurate results.

Single photon counting is compatible with both steady state and time-resolved data acquisitions. We employ photon counting for standard spectral and kinetic measurements and have proprietary electronics to accurately record the arrival time of each photon for fluorescence lifetime measurements down to a few picoseconds.

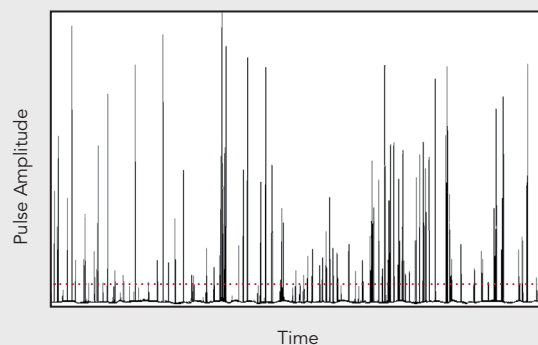

Electron pulses from single photons. Only pulses with amplitude higher than a pre-set threshold (red) are being processed.

STRAY LIGHT

The FLS1000 exhibits high stray light suppression. This reduces the possibility of stray or scattered light swamping weak fluorescence or phosphorescence signals. The instrument's single monochromators have a stray light rejection of $1:10^5$, which allows the user to study weakly emitting and challenging samples without background interference.

For samples with a high level of scattering, such as powders or thin-films, we recommend the FLS1000 with double monochromators, giving an industry-leading stray light rejection of $1:10^{10}$.

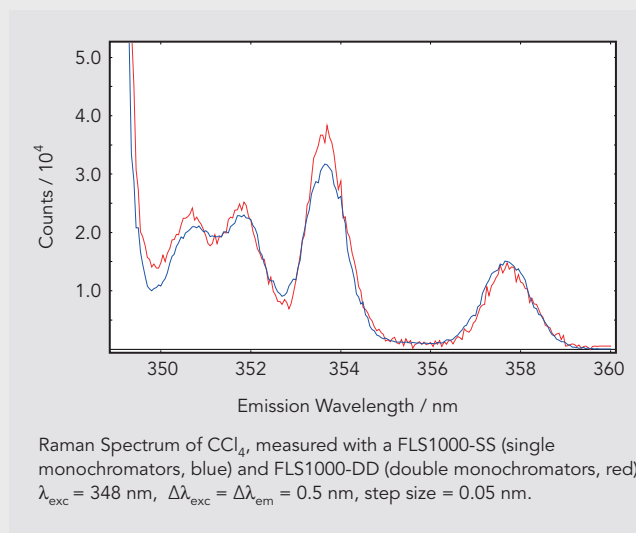

EFFICIENT OPTICAL PATHWAYS AND LIGHT COLLECTION

Ultimate system performance requires optimisation throughout. This includes the use of highly efficient and long term stable optical components, accurate and wavelength independent focusing, robust precision mechanics, effective elimination of potential artefacts, as well as tried and tested spectral correction algorithms; all found in the FLS1000.

For wider spectral coverage, better temporal performance, or optimisation of sensitivity at particular wavelengths, the FLS1000 can automatically change gratings, sources, detectors or whole optical pathways. The design principle of the FLS1000 is the optimisation of the overall system, not just their individual components.

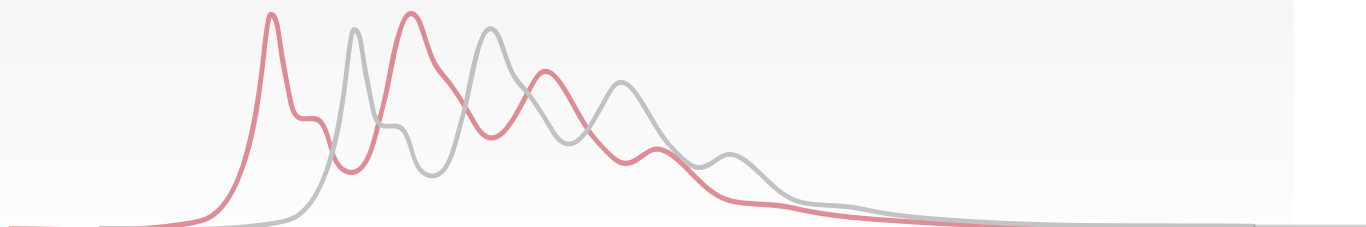

SENSITIVITY - WHERE YOU NEED IT

The FLS1000 provides the highest specification of sensitivity on the market. This is because of single photon counting detection, high quality optical pathways, the use of dedicated and optimised light sources and the hand-picked, most sensitive detectors on the market.

Rather than employing alternative measurements or complicated calculation procedures, we use the straightforward SQRT method for sensitivity validation:

$$SNR_{SQRT} = \frac{\text{Signal at } \lambda_{\text{peak}} - \text{Signal at } \lambda_{\text{bkgrd}}}{SQRT(\text{Signal at } \lambda_{\text{bkgrd}})}$$

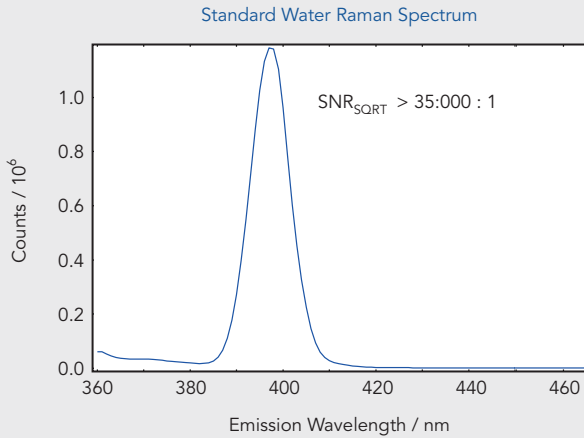

Raman spectrum of ultra-pure water, standard in UV/blue spectral range
 $\lambda_{\text{exc}} = 350 \text{ nm}$, $\Delta\lambda_{\text{exc}} = \Delta\lambda_{\text{em}} = 5 \text{ nm}$, step size = 1 nm, int time = 1 s, $\lambda_{\text{peak}} = 397 \text{ nm}$, background noise measured at 450 nm.
 FLS1000-DD configuration

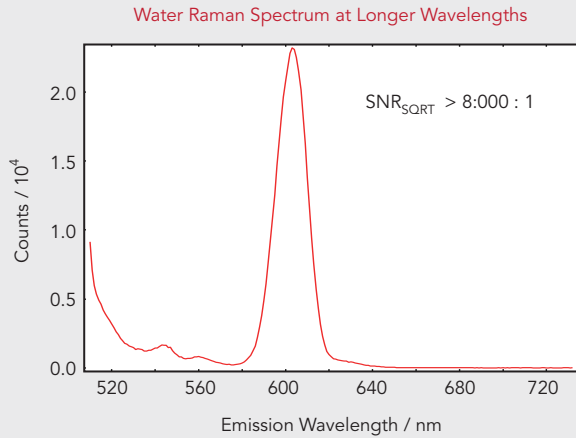

Raman spectrum of ultra-pure water at longer wavelength range
 $\lambda_{\text{exc}} = 500 \text{ nm}$, $\Delta\lambda_{\text{exc}} = \Delta\lambda_{\text{em}} = 5 \text{ nm}$, step size = 1 nm, int time = 1 s, $\lambda_{\text{peak}} = 603 \text{ nm}$, bkgnd noise measured at 730 nm

The water Raman signal has a strong wavelength dependence. This is caused by the Raman cross section itself, but also by many instrumental parameters, such as spectral dependence of the source, grating efficiencies and detector responsivity.

Selecting the best "standard" water Raman specification might not always be beneficial, depending on what wavelength range you work in. For this reason Edinburgh Instruments offers alternative solutions, with maximum sensitivity in your desired wavelength range. Select your optimised pathway by the click of a mouse.

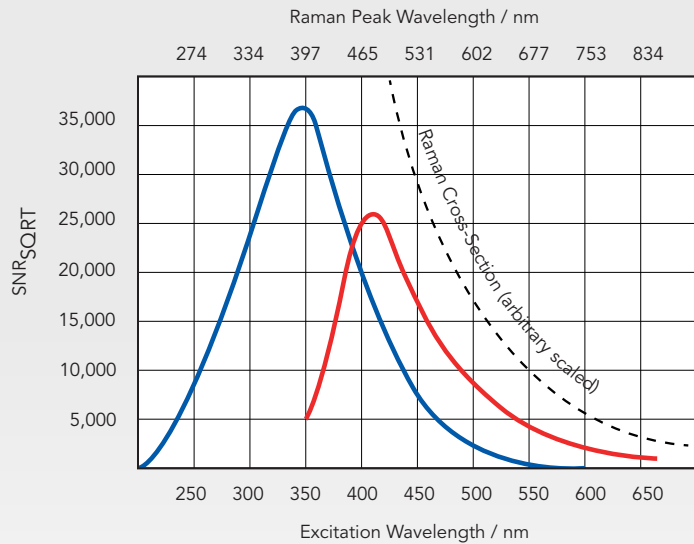

Typical spectrally dependent sensitivity characteristics for a system that has been optimised for the standard Raman signal (blue), and an alternative offering (red). The true functions are more structured due to source and grating features.

SPECTRAL RANGE

Modern applications show that it is increasingly important to study photoluminescence phenomena over a broad spectral range from the deep ultraviolet to the infrared.

The FLS1000 is supplied with computer-controlled, kinematic triple grating turret monochromators, with up to three different gratings permanently fitted. This allows a large spectral range to be covered and provides maximum flexibility and ease of use.

Each grating is individually optimised for both spectral range and linear dispersion. Grating selection, wavelength tuning and slits are all controlled via the Fluoracle software.

Computer-controlled mirrors allow rapid selection of light sources and detectors. Two detectors can be mounted on a single emission monochromator and three on a double emission monochromator. Single photon counting photomultipliers are available covering the wavelength range from 200 nm to 1700 nm, while analogue detectors extend the wavelength coverage up to 5500 nm.

SPECTRAL RESOLUTION

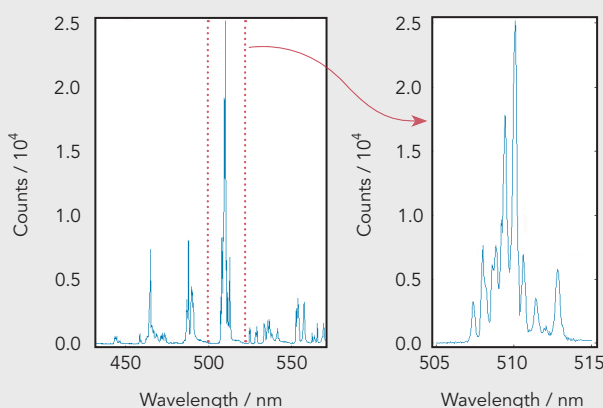

Europium emission spectrum demonstrating the fine resolution achievable with the FLS1000

The FLS1000 uses 325 mm focal length Czerny-Turner monochromators with high quality diffraction gratings for high dispersion of light and excellent imaging quality. Wavelength tuning is micro-stepper motor driven with a minimum step size of 0.01 nm. This, together with an exceptional high spectral resolution, ensures spectral details as low as 0.05 nm can be resolved*.

* grating dependent



SPECTRAL CORRECTION

Spectral correction is necessary to obtain the true excitation and emission spectra of the sample, free from any instrumental effects. Comprehensive spectral correction, using factory measured correction files, is standard practice when using the FLS1000.

Uncorrected excitation spectra are affected by the spectral output of the light source and the throughput of the monochromator. The correction file is obtained using the built-in calibrated reference detector that monitors a small fraction of the excitation light.

Similarly, raw emission spectra are affected by the monochromator efficiency and the spectral response of the detector. Unique correction files for each spectrometer and grating/detector combination are obtained during calibration at the Edinburgh Instruments factory. With a simple mouse click, the FLS1000 produces corrected spectra you can trust.

Edinburgh Instruments provides correction files in photon irradiance units. This means that all photoluminescence spectra present the number of photons per unit bandwidth.

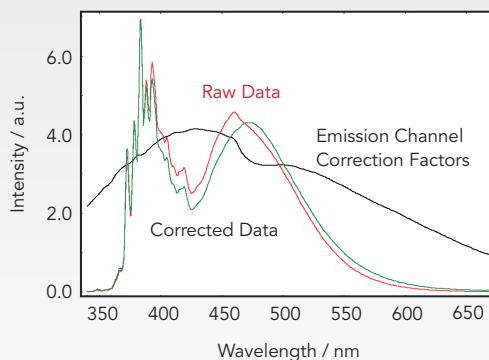

The effect of spectral correction shown on a typical emission spectrum using pyrene in cyclohexane.

FLUORACLE® SOFTWARE INTERFACE - SPECTRAL MEASUREMENTS

Measurement Modes

- Live signal rate with overload indication
- Excitation, emission, synchronous and anisotropy spectra, as individual scans or multiple measurements
- Kinetic scans with source control functions
- Excitation emission maps (EEMs)
- Absolute quantum yield
- Absorption by transmission or by reflectance
- Temperature scans and maps
- Batch measurements (spectral, lifetime and combined)
- Service scans for spectrometer performance validation

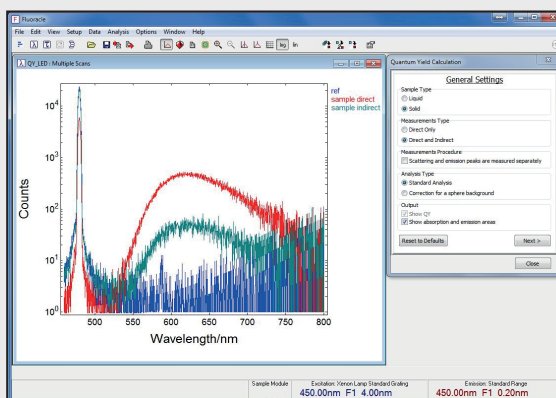

Quantum Yield Wizard

Control Features

- Selection of excitation and emission optical pathways
- Selection of wavelengths, gratings, spectral bandwidths and integration time
- Source and detector selection
- Programmed excitation attenuator and shutters
- Spectral correction during or post acquisition
- Polariser selection and orientation
- Sample selection (multiple cuvette holders & plate reader)
- Control of advanced accessories: X-Y sample stage, cryostat, microscope stage, plate reader, titrator, etc
- Detector gating for phosphorescence spectra
- Control and monitoring of light sources
- Temperature control of sample

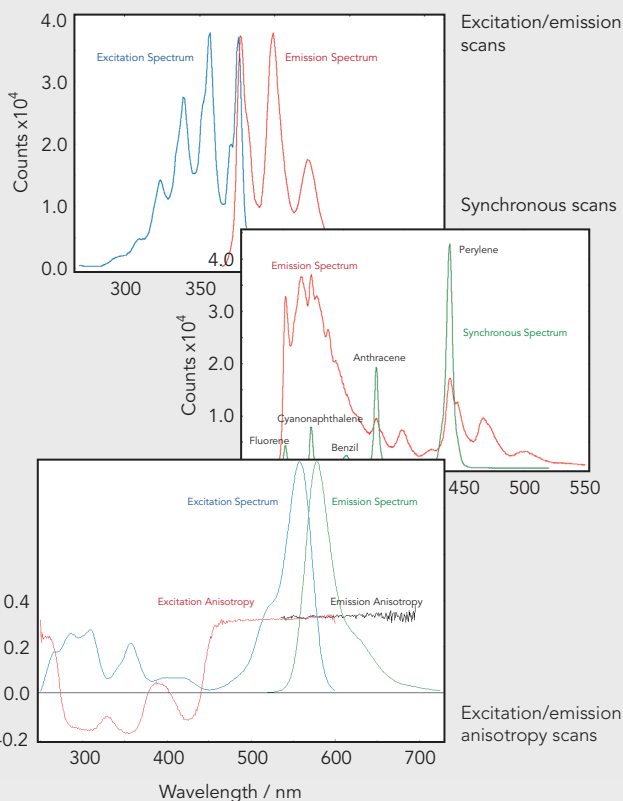

Data Operations & Display

- Arithmetic (+, -, ×, /, append), differentiation and integration
- Scaling, normalisation and baseline subtraction
- Cropping and smoothing data
- Grid display, logarithmic/linear scales
- 2D, 3D, contour and colour maps
- Data in text display and editing option
- Peak search function
- Spectral correction and anisotropy analysis
- Absolute quantum yield wizard
- Chromaticity calculation and display wizard (CIE 1931, CIE 1976)
- Comprehensive measurement and file properties for record keeping
- ASCII/CSV data import and export options
- Copy and paste options to facilitate presentations and publications

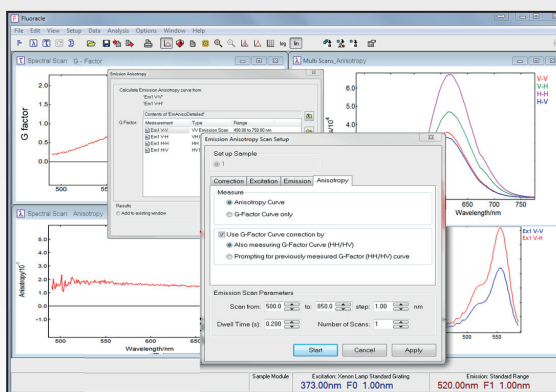

Anisotropy Measurement Wizard

OVERVIEW

Edinburgh Instruments has pioneered single photon counting lifetime technologies and continues to be at the forefront of advances in electronics, light sources and detector technologies.

Our unique data acquisition module combines conventional single photon counting (for spectral acquisitions) with multi-channel scaling (MCS) and time-correlated single photon counting (TCSPC) with up to three light sources and three different detectors operating simultaneously.

A photoluminescence lifetime range spanning over 12 orders of magnitude is covered with one state-of-the-art electronic module containing multiple 100 MHz counters for high dynamic range.

For the most complex FLS1000 systems our electronic modules can operate in parallel, ensuring that no changes of cables or other hardware components are required by the user.

All setup and control functions of the data acquisition electronics are embedded into the spectrometer operating software, Fluoracle. Complex hardware functions are factory configured; however, full configurability and flexibility is still possible within the password protected service area. Changing from spectral to lifetime measurements is a mouse click away. The user can focus solely on measuring your sample and the interpretation of your first class data.

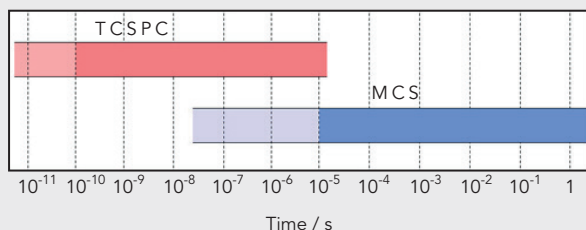

The graphic illustrates the range of photoluminescence lifetimes that can be covered with TCSPC and MCS. The darker shaded ranges are covered with FLS1000 standard light sources and detectors. TCSPC can be extended down to a few picoseconds, with picosecond or femtosecond lasers and MCP detectors. MCS can be extended down to 10 ns with nanosecond or picosecond pulsed, moderate repetition rate light sources.

MCS - PHOSPHORESCENCE LIFETIME MEASUREMENTS

MCS is a digital technique for the acquisition of single photons with a time resolution from 10 ns to seconds.

Photons are counted in a time window (or time bin) which sweeps across the full time range following each excitation pulse. This produces a measurement form of counts (per bin width) versus time. Repeated sweeps then improves data quality. The time to measure a high quality decay can be a fraction of a second, although this varies depending on sample lifetime, source frequency and sample quantum yield.

Lifetimes from around 10 ns can be realistically measured with suitable narrow pulsed excitation sources.

Sources for this technique should operate at less than 1 MHz and include the standard microsecond flashlamp, picosecond or nanosecond pulsed lasers and LEDs, as well as variable pulse width sources in the range of nanoseconds to microseconds.

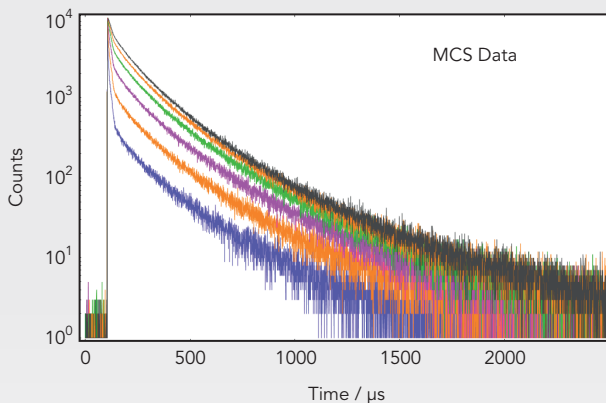

Photoluminescence decays of an OLED thin film sample.

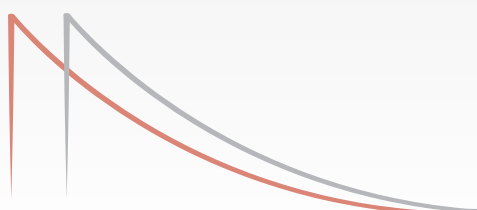



FLS1000 Fluorescence and Phosphorescence Lifetime Spectrometer with EPL for TCSPC measurements and microsecond pulsed laser for MCS measurements.

TCSPC - FLUORESCENCE LIFETIME MEASUREMENTS

TCSPC is a digital technique for the acquisition of single photons with a time resolution below 5 ps.

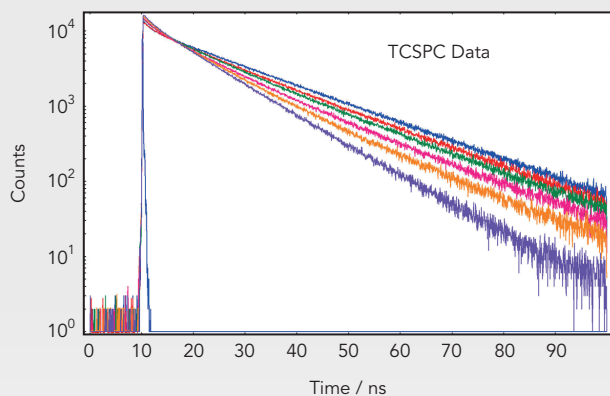

Fluorescence decays of an organic dye used in a caspase assay for monitoring peptide cleavage by enzymes.

In TCSPC the sample is excited using a high repetition pulsed light source and a maximum of one single photon is counted following each excitation pulse. With typically $10^5 - 10^7$ repetitions per second, a probability histogram of photon arrival times will be produced in a short period of time.

The fact that the time at which a fluorescence photon is incident on the detector can be determined with picosecond accuracy is critical to the high time resolution in TCSPC. This accurate timing is achieved with special electronic components such as Constant Fraction Discriminators and Time-to-Amplitude Converters.

Although TCSPC can in principle be done with any pulsed light source, best performance is achieved with high pulse repetition rates and narrow picosecond pulses. The high repetition rate ensures short measurement times, while narrow pulses are required to resolve short fluorescence lifetimes.

Single-wavelength pulsed diode lasers and LEDs are the classic choice of sources for TCSPC experiments. A white-light pulsed supercontinuum laser may also be coupled to the excitation monochromator providing tunable wavelengths across the visible and NIR range.

STANDARD FLUORESCENCE LIFETIME DATA ANALYSIS

Fluoracle provides standard fluorescence and phosphorescence decay analysis tools, including tail fitting and numerical reconvolution options. With numerical reconvolution, short lifetime components can be extracted from the raw data which would otherwise be distorted or masked by the instrumental profile.

The standard analysis routine provided is based on the Marquardt-Levenberg algorithm. Up to four exponential decay components can be fitted, with shift and offset fitting as standard. The algorithm is robust, delivers results in a blink of an eye, and is presented in a user-friendly interface.

Additional fit quality parameters are available for quality assessment, such as autocorrelation functions, the Durbin-Watson parameter and standard deviations.

The example shows results of a reconvolution fit with tests against three multi-exponential decay models. Although a 4-exponential model provides an adequate fit the validity of 4-exponentials should be justified against the sample's and the experiment's conditions.

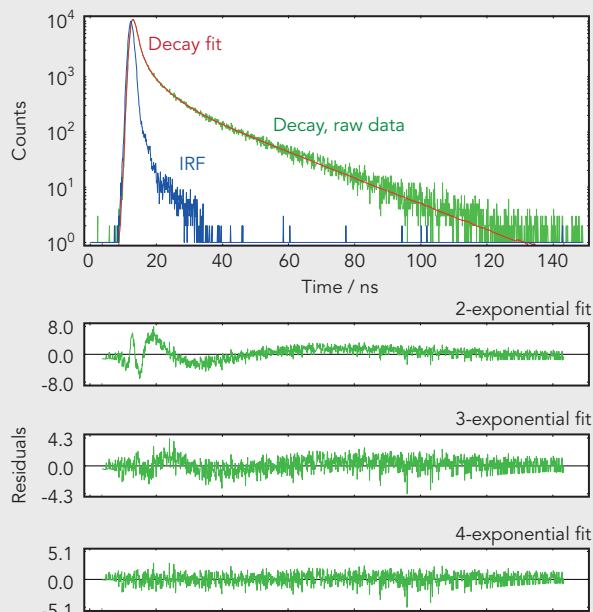

ADVANCED FLUORESCENCE LIFETIME DATA ANALYSIS

For the advanced analysis of fluorescence and phosphorescence decay kinetics, Edinburgh Instruments offers the Fluorescence Analysis Software Technology (FAST) package. This software package sets new standards in precision, robustness and speed of fluorescence lifetime data recovery. FAST provides unsurpassed accuracy and fits are 100% convergent.

FAST contains a library of advanced data reconvolution and curve fitting routines based on proprietary data processing algorithms, which surpass the conventional Marquardt-Levenberg algorithm in both speed and reliability.

Despite the sophisticated and challenging analysis models, FAST is easy to operate, with an intuitive and

user friendly interface. A wide range of data input, on screen visualisation, hardcopy and clipboard facilities are available.

Multiple sets of data can be analysed simultaneously. This is particularly useful for larger data sets such as in assay development and screening.

FAST Advanced Analysis Tools

- Exponential components analysis
- Support plane analysis for the calculation of lifetime confidence intervals
- Lifetime distribution analysis with up to 200 lifetimes
- Global exponential components analysis
- Stretched exponential components analysis
- Förster kinetics analysis
- Micellar quenching kinetics analysis
- Analysis of time-resolved fluorescence anisotropy kinetics

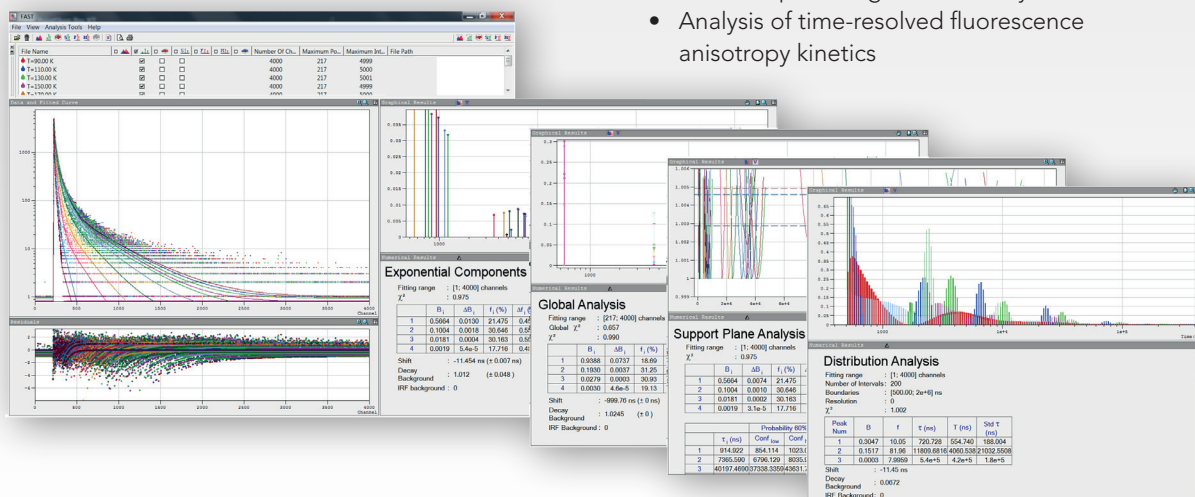

FLUORACLE® SOFTWARE FUNCTIONALITY FOR TIME-RESOLVED DATA

Measurement Modes

- Live signal rates with overload and pulse pile-up indication
- Manual and multiple measurements of photoluminescence decays and instrumental response function
- Time-resolved excitation and emission spectra
- Time-resolved fluorescence anisotropy
- Temperature-dependent lifetime measurements
- Multiple sample position and well-plate measurements
- Batch measurements

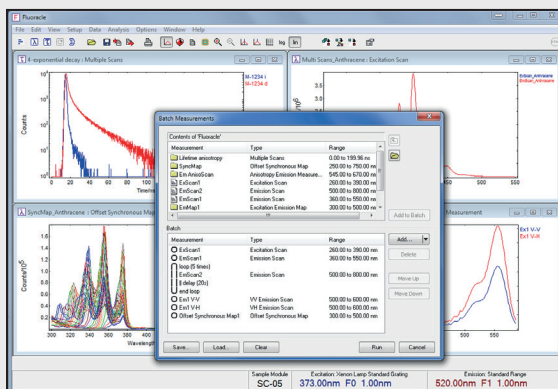

Batch Measurement Setup

Control Features

- Wavelength and bandwidth selection for excitation and emission monochromators
- Selection of gratings, sources and detectors
- Control of multiple TCSPC and MCS sources
- Programmable signal intensity attenuator
- Control of polarisers, cryostat, temperature settings, multi-position sample holders, etc
- Measurement stop conditions: peak counts, number of sweeps or pre-set time
- Forward or Reverse TCSPC mode (with built-in delays and no cable change)
- Time range and channel selection

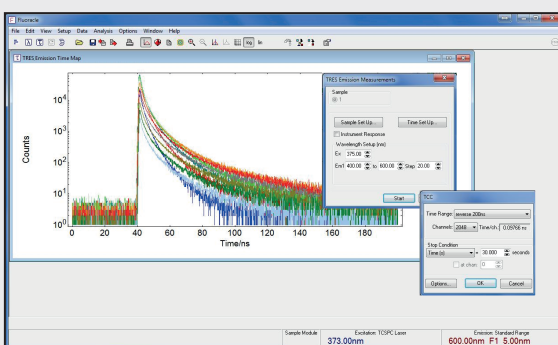

TCSPC TRES Measurement Setup

Data Operations, Analysis and Displays

- Arithmetic (+, -, ×, /, append)
- Scaling, normalisation and baseline subtraction
- Cropping
- Grid display, logarithmic/linear scales
- 2D, 3D, contour and colour maps
- Data in text display and editing option
- Full decay data fitting using a non-linear least square fitting routine
- Exponential reconvolution or tail fit
- 1-4 independent exponential decay times, fixed or as free fit parameters
- Shift parameters, fixed or as a free fit parameter
- Background fit, fixed or as a free fit parameter
- Chi-squared goodness-of-fit test
- Weighted residuals, Durbin-Watson parameter
- Autocorrelation function
- Anisotropy calculation
- Extraction of time-resolved spectra (TRES data slicing)
- Comprehensive measurement and file properties for record keeping
- ASCII/CSV data input and output options
- Copy and paste options to facilitate presentations and publications
- Optional Advanced Fluorescence Lifetime Data Analysis Package

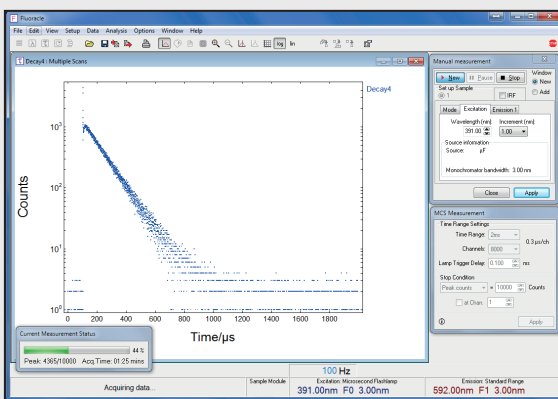

Single MCS Measurement Setup

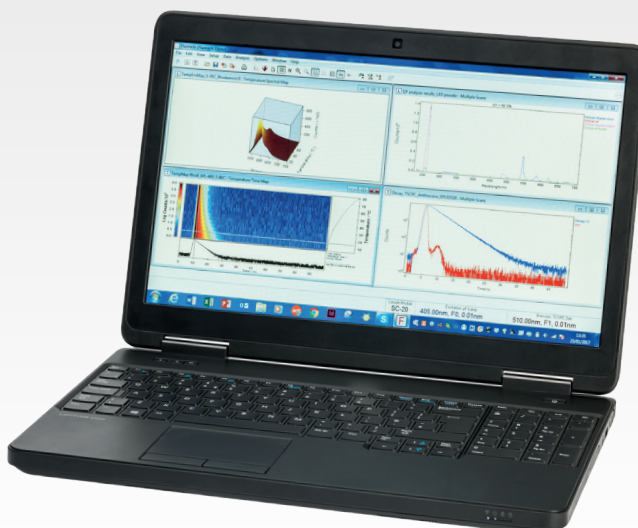

EEMs – THE FINGERPRINT OF COMPLEX SAMPLES

Complex samples often exhibit complex emission 'landscapes'. An Excitation-Emission Map (EEM) is simple to produce and it contains all the spectral information (in respect to fluorescence/phosphorescence emission) of the sample. Suitable graphics offer a fast visual assessment.

With the FLS1000's fast wavelength scanning, high performance ultrafast photon counting electronics, and automated filter wheels for second order elimination, EEMs can now be rapidly obtained. EEMs are often the starting point for more detailed spectroscopy research of completely unknown samples and can be used to quickly establish the global maxima of sample excitation and emission.

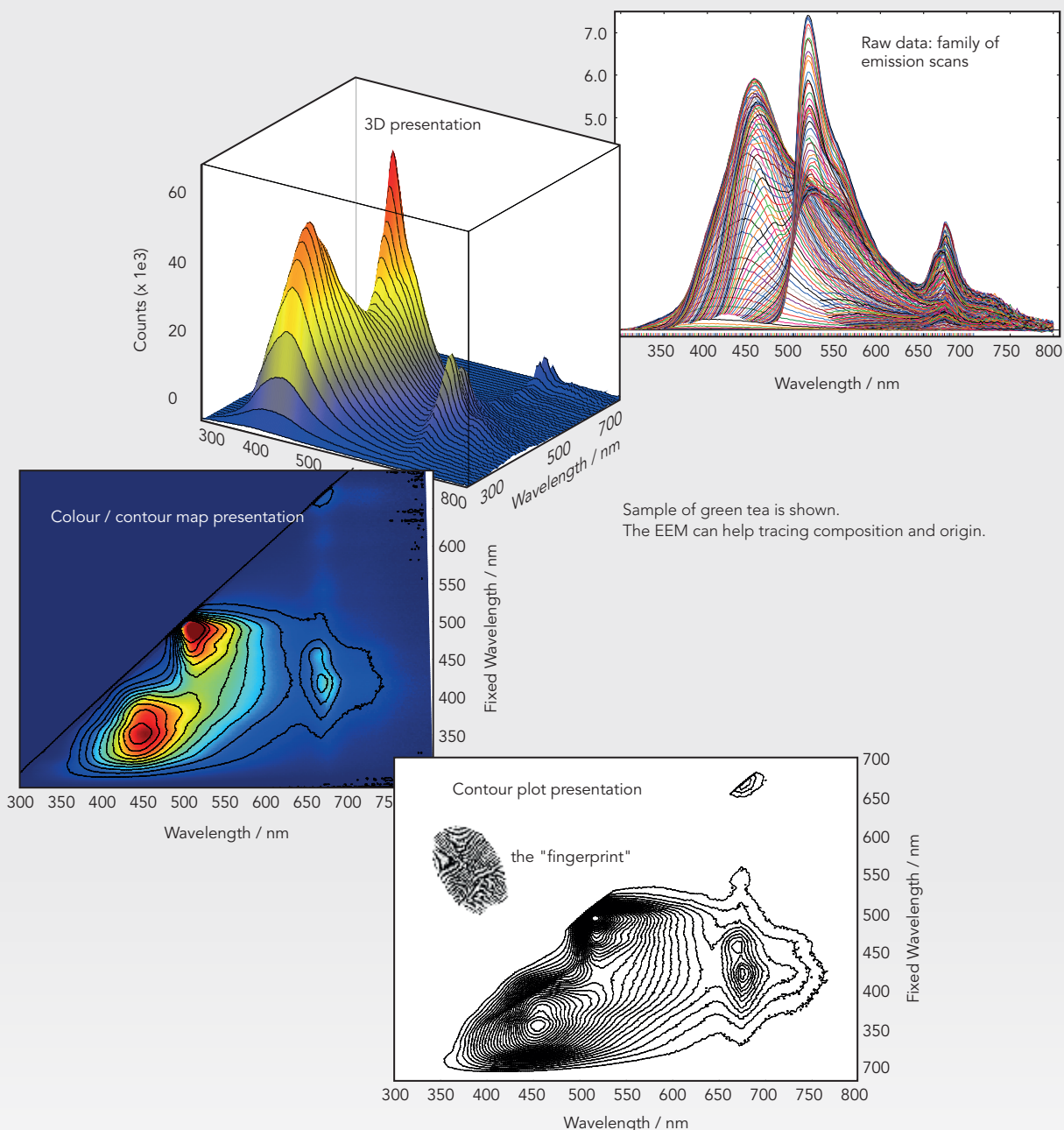

Automated map measurements are also possible with other parameters such as temperature, concentration, sample position, or temporal resolution.

With the FLS1000 a wide range of accessories are fully controlled through the spectrometer operating software Fluoracle. This facilitates all automated map measurements.

TRES - THE POWER OF ADDED TEMPORAL RESOLUTION

The measurement of Time-Resolved Emission Spectra (TRES) is a very powerful tool in photoluminescence spectroscopy.

With TRES measurements, a family of decay curves is automatically acquired as a function of wavelength. Suitable data presentation and global analysis of the whole set of decays reveals spectacular sample dynamics that are impossible to obtain with any other spectroscopy techniques.

TRES acquisitions can be made with both MCS and TCSPC and is therefore applicable to both fluorescence and phosphorescence phenomena.

For acceptable measurement times it is important to select a suitable light source not only in respect to wavelength, pulse width and pulse repetition rate, but also with sufficient optical power.

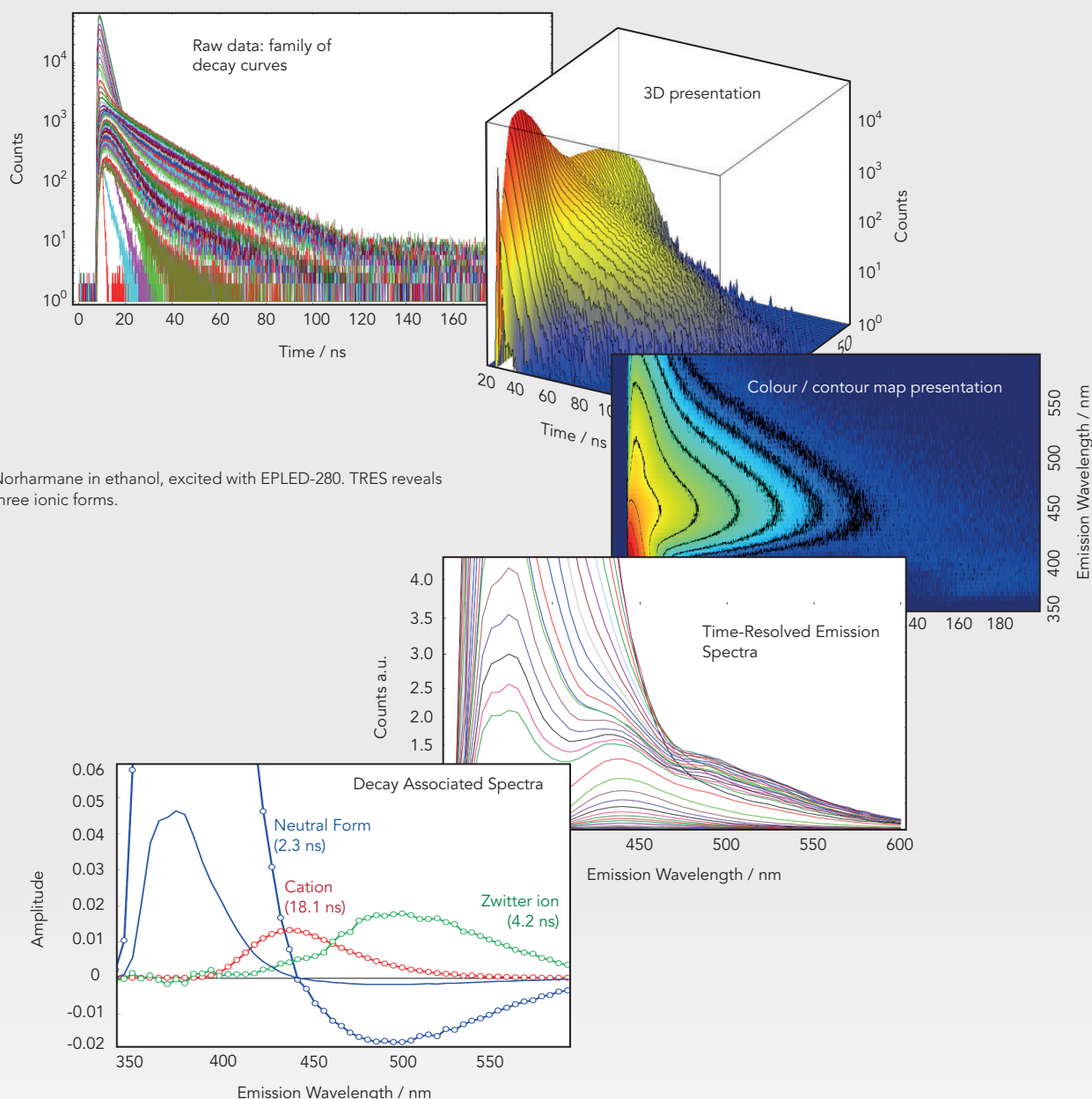

Norharmine in ethanol, excited with EPLED-280. TRES reveals three ionic forms.

If a tunable excitation source is used, the FLS1000 can perform both excitation and emission TRES providing maximum flexibility. The data slicing option in Fluoracle allows to easily convert the family of decay curves into a family of time-resolved emission spectra.

Using the advanced lifetime analysis software, FAST, the whole set of decay curves can be fitted with global lifetime parameters. This results in the Decay Associated Spectra that show the true relation between sample spectra and fluorescence/phosphorescence dynamics.



EDINBURGH
INSTRUMENTS

AGILE
Picosecond Pulsed

DTGM325-X

EDINBURGH
INSTRUMENTS

EPLED-250
Picosecond Pulsed Laser

Control panel with a dial and a yellow warning label.

EDINBURGH
INSTRUMENTS

MANUFACTURED
WITH PRIDE IN THE
UNITED KINGDOM

EXCITATION SOURCES

Xe2 Xenon Arc Lamp

The Xe2 is a 450 W xenon arc lamp that emits continuous radiation from 230 nm to >1000 nm. The light from the xenon arc is focused into the monochromator by means of a high-reflectivity off-axis ellipsoidal mirror, ensuring excellent focus at the entrance slit and completely uniform illumination of the monochromator grating. An ozone generating lamp can be supplied to extend the lamp output down to less than 200 nm.

μF2 Microsecond Flashlamp

The μF2 is a 60 W pulsed xenon flashlamp producing short, high irradiance optical pulses at repetition rates up to 100 Hz in the spectral range from 200 nm to >1000 nm. With a typical pulse width of 1 μs, this lamp is an ideal source for decay measurements in the range from microseconds to seconds.

AGILE – Tunable Picosecond Light Source

AGILE is a wavelength-tunable, high brightness supercontinuum laser that couples directly into the excitation monochromator. This offers continuous spectral output from <400 nm to >2000 nm and ~200 ps pulses with repetition rates from 10 kHz to 1 MHz, making it the ideal light source for TCSPC applications.

VPL / VPLED – Adjustable Pulsed Diode Lasers & LEDs

VPL and VPLED sources are designed for MCS and provide adjustable pulse widths from 50 ns to 1 ms, enabling the user to optimise the excitation power for each specific sample. They are externally triggered and can operate in CW mode. Wavelengths from 255 nm to 1,300 nm are available.

EPL / EPLED – Picosecond Pulsed Diode Lasers & LEDs

EPL-series lasers and EPLED light emitting diodes produce picosecond pulses at repetition rates up to 20 MHz. These compact sources can operate in internal or external trigger mode for TCSPC or MCS measurements. EPL lasers are available from 375 nm to 980 nm with typical pulse widths <100 ps. EPLED diodes provide sub-nanosecond pulses from 250 nm to 610 nm.

HPL – High Repetition Rate / High Power Picosecond Pulsed Diode Lasers

The HPL lasers are optimised for TCSPC at high repetition rates up to 80 MHz, with wavelengths between 375 nm and 800 nm. They can run in standard mode, with similar characteristics to the EPL series, or in high power mode with up to 10 times higher power.

nF920 Nanosecond Flashlamp

The nF920 is a pulsed flashlamp with sub-nanosecond optical pulses and repetition rates up to 100 kHz. The lamp is typically filled with hydrogen gas with a spectral output from 200 nm to >400 nm. The lamp can be used as a pulsed VUV source with spectral output down to 115 nm.

Alternative Excitation Sources

- High power diode lasers with continuous or pulsed excitation for upconversion and IR measurements
- Ti:Sapphire lasers
- 5 W microsecond flashlamp
- Q-switched solid state lasers and their harmonics (e.g. Nd:YAG)
- Deuterium lamp coupled to VUV excitation monochromator for continuous excitation in the range of 115 nm - 400 nm
- Pulsed and CW X-Ray sources in additional sample chamber XS1

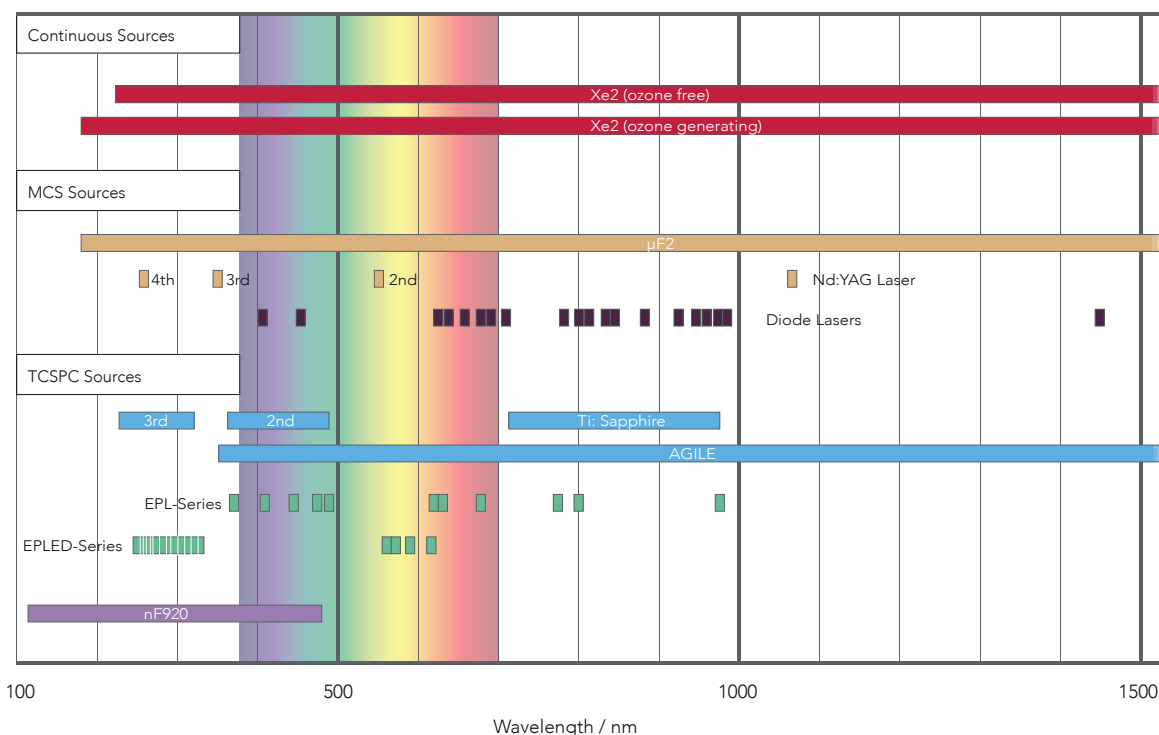

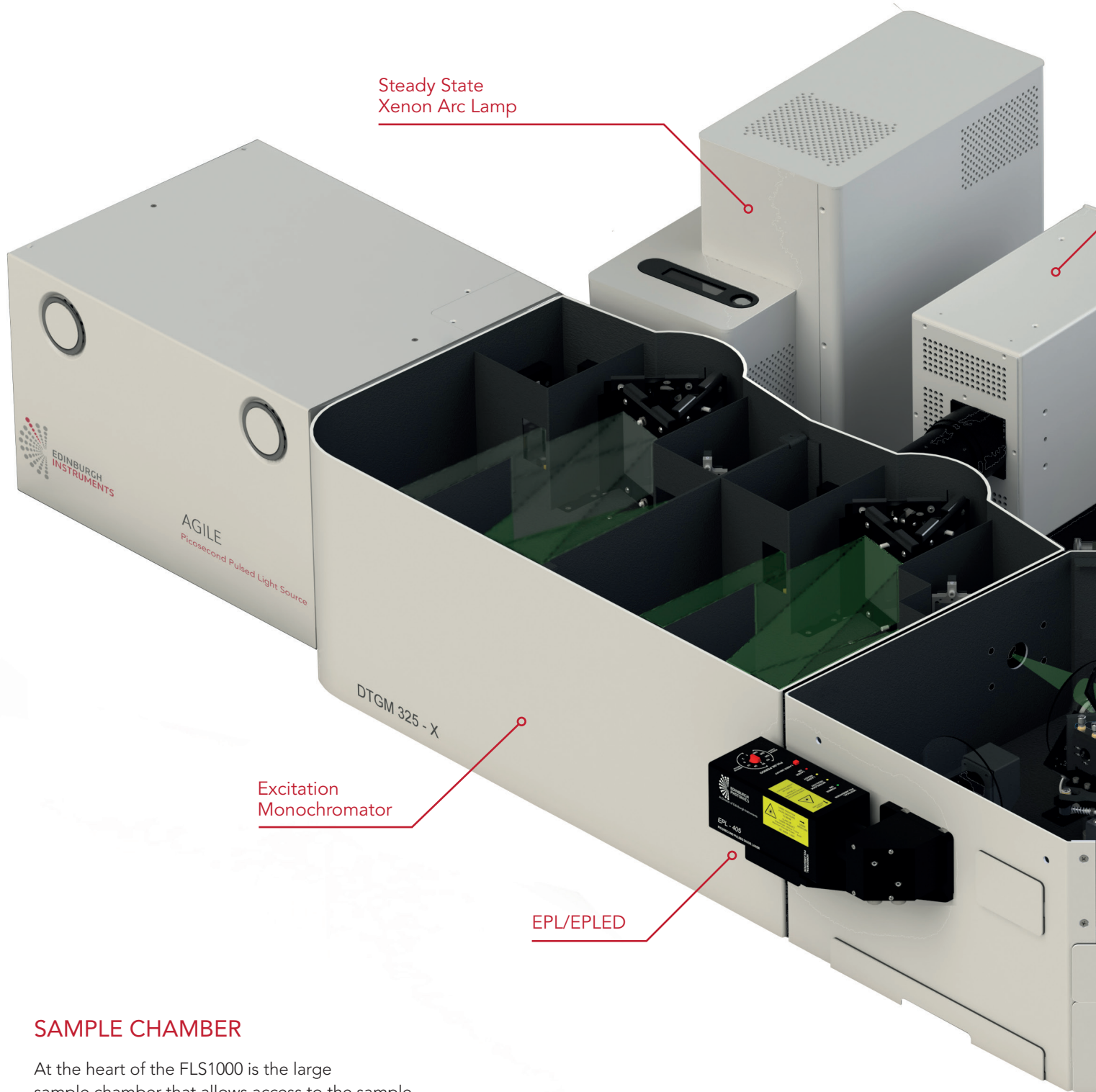

SAMPLE CHAMBER

At the heart of the FLS1000 is the large sample chamber that allows access to the sample from 8 different axes, including top and bottom. The focusing optics within the sample chamber consist of fused silica lenses as standard. Mirror optics can be installed for special front-face applications with narrow angles between emission and excitation beams or for infrared applications, where transmission optics may not be suitable.

The excitation power may be attenuated by a computer-controlled neutral density filter in the excitation path. Motorised high quality polarisers with 14 mm clear aperture can be provided for anisotropy studies. Polarisers are available with operating ranges of 220 nm to 900 nm and 240 nm to 2300 nm.

An additional laser input port on the side of the sample chamber provides access for external lasers. The beam is steered along the standard excitation path which ensures flexibility and consistency for sample holder options such as the front-face sample holder or integrating sphere.

There are a wide range of sample holders available to suit most applications. The bottom access to the sample chamber ensures compatibility with top-loading cryostats and simplifies both access and alignment of other sample holders. The large FLS1000 chamber lid is hinged to facilitate full service access to all internal optical components.

FLS1000 COMBINED STEADY STATE & TIME-RESOLVED PHOTOLUMINESCENCE SPECTROMETER

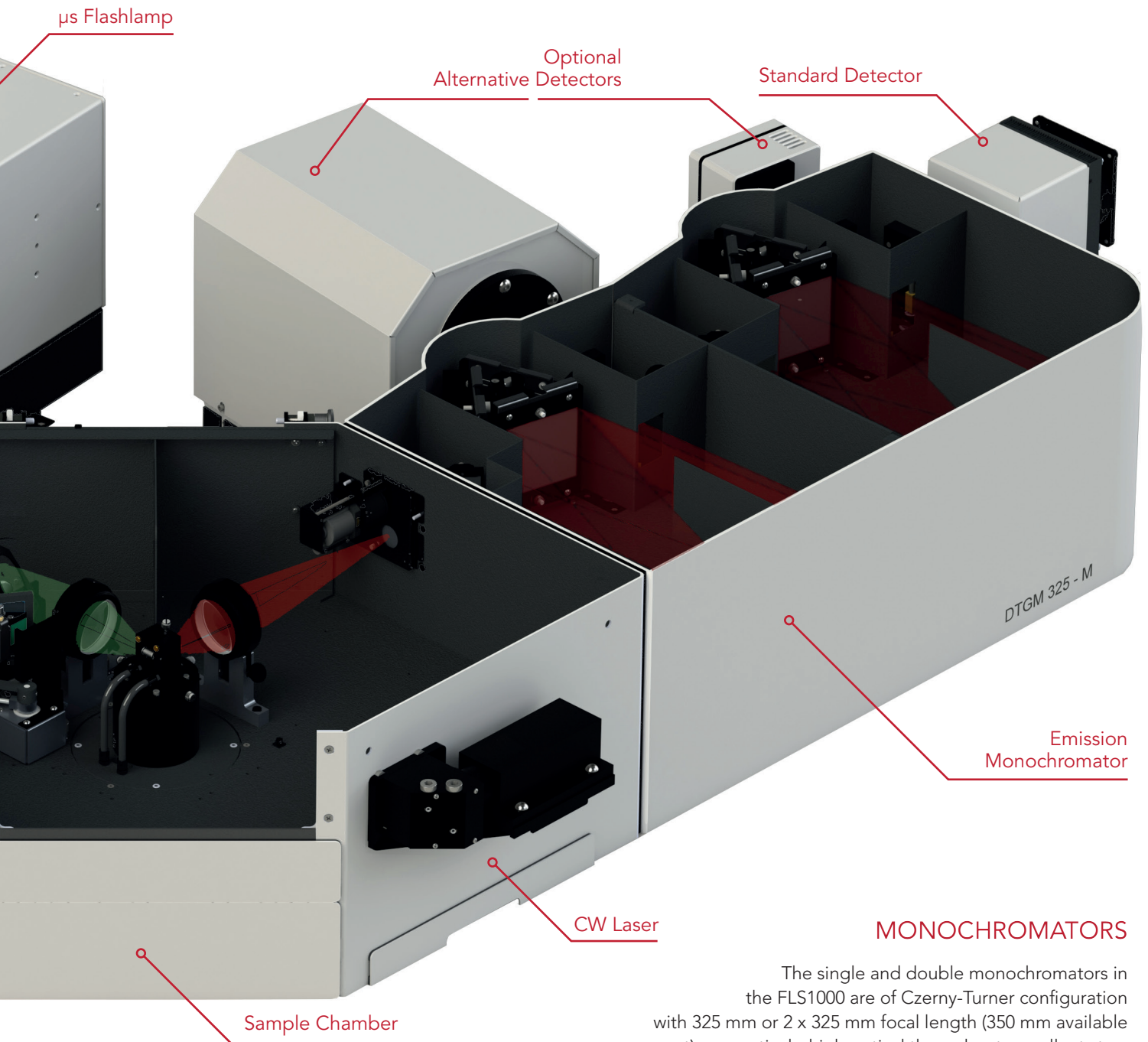

MONOCHROMATORS

The single and double monochromators in the FLS1000 are of Czerny-Turner configuration with 325 mm or 2 x 325 mm focal length (350 mm available upon request), respectively, high optical throughput, excellent stray light rejection and low temporal dispersion. The monochromators feature triple grating turrets with up to three gratings on each turret computer-controlled slits and detector selection mirrors.

A range of high quality holographic and plane ruled gratings is available. The grating turrets provide a minimum step size of 0.01 nm, which ensures that very fine spectral features can be resolved well below 0.05 nm.

Excitation monochromators have integrated shutters for controlling sample light exposure, while interlock shutters in the emission path provide detector protection.

All monochromators come with a filter wheel for higher order removal and further stray light control. Up to 7 light sources and 8 detectors can be permanently attached and operated with more complex FLS1000 systems.

The FLS1000 can be configured with a spectrograph instead of a standard monochromator if an array detector is used. Vacuum ultraviolet (VUV) monochromators are also an option for both excitation and emission light paths.

DETECTORS

Standard Detector

PMT-900 in cooled housing

This PMT has a wavelength coverage of 185 nm to 900 nm and a dark count rate of <50 cps (cooled to -20°C). The detector is operated in single photon counting mode throughout all time ranges. When operated in TCSPC mode the detector response width is ~600 ps.

Enhanced Temporal Response Options

High speed PMT in cooled housing (HS-PMT Series)

These detectors have a slightly reduced overall sensitivity, but with a narrower, 180 ps, detection response width in TCSPC applications. The spectral coverage is 230 nm to 870 nm, with a dark count rate of <100 cps (at 0°C). An extended range version up to 920 nm is available.

MCP-PMT in cooled housing

This is the best detector for fast TCSPC measurements. This MCP-PMT has a wavelength coverage from 160 nm to 850 nm and a detector response width of <25 ps. The detector assembly features a dark count rate of <50 cps (at -20°C). An extended range version up to 910 nm is available.

CCD and Array Detectors

CCD cameras and diode arrays for the visible and NIR spectral range are optional. These detectors are recommended for fast acquisition of spectral maps. CCD coverage is provided from 200 nm to 1100 nm. NIR array detectors range from 600 nm to 1700 nm.

Enhanced Spectral Response Options

PMT-980 in cooled housing

Side window photomultiplier with extended spectral range from 185 nm to 980 nm. This detector retains the high quantum efficiency and temporal performance of the standard PMT-900 detector.

PMT-1010 in cooled housing

Side window photomultiplier with spectral range from 185 nm to 1010 nm. Fitted with internal pre-amplifier.

PMT-1400 & 1700 in cooled housing

NIR-PMTs enable photon counting operation up to ~1700 nm. Liquid nitrogen cooled and TE-cooled versions are available.

PMT-230 in evacuated housing

Side window photomultiplier with a spectral range of 115 nm - 230 nm. This detector is used together with an evacuated VUV emission monochromator.

Analogue InGaAs Detectors

Thermoelectrically cooled InGaAs detectors with spectral coverage up to ~1.65 μm, 2.05 μm and 2.55 μm are available. These detectors are suitable for steady state and lifetime in the μs and ms time range.

Analogue InAs & InSb Detectors

Analogue detectors with 3.1 μm and 5.5 μm cut-off wavelengths, suitable for steady state and lifetime in the μs and ms time range. These are liquid nitrogen cooled and are equipped with dedicated excitation and emission lock-in amplifier for enhanced sensitivity and removal of thermal emission.

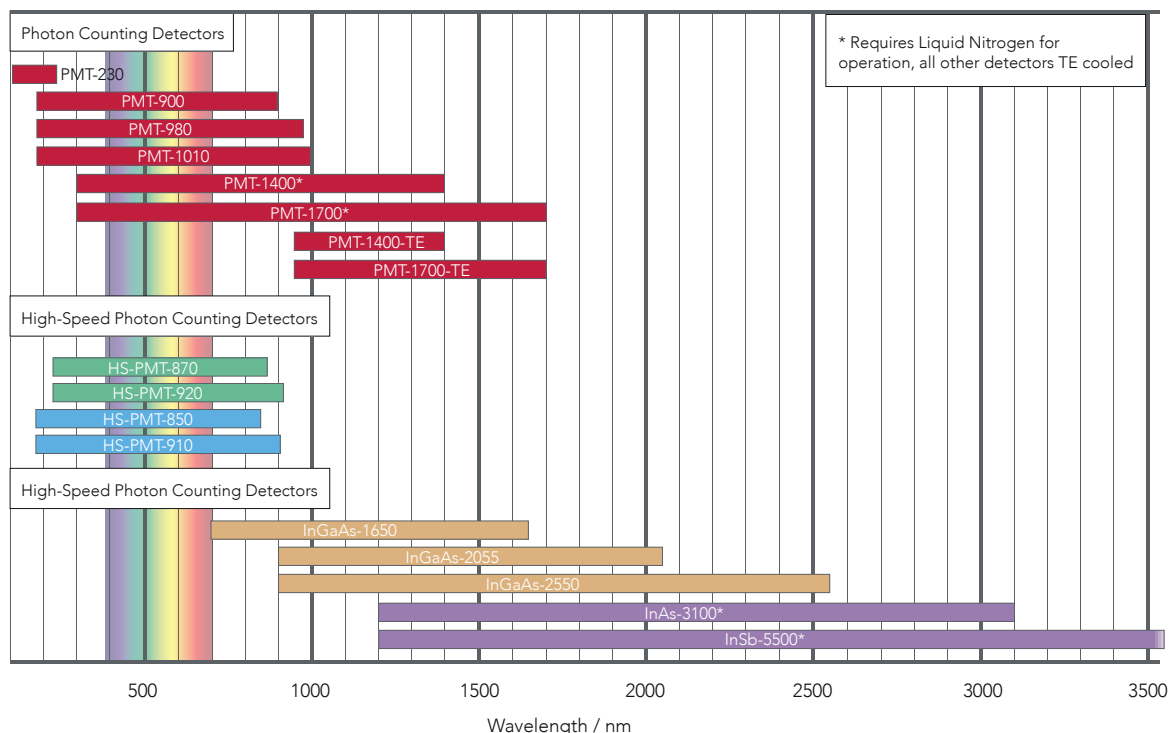

UNFOLD THE FUTURE OF PHOTOLUMINESCENCE



Standard Cuvette Holder

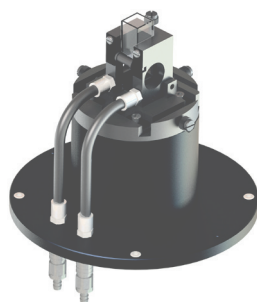

The standard FLS1000 cuvette holder is designed for accurate positioning of standard fluorescence cuvettes with an optical beam height of 15 mm. The holder comprises an integrated temperature sensor and is suitable for temperature control by an external fluid circulator. The assembly comes with filter holders as standard and can be upgraded with a magnetic stirrer.

TE-Cooled Sample Holder



The thermoelectrically (TE) cooled cuvette holder is fully controlled by Fluoracle software. Fixed temperature and temperature map measurements from below 0°C to above 100°C can be carried out.

4-position TE-Cooled sample holders and versions with extended temperature range are also available.

Solid Sample Holders



The front-face sample holder offers external adjustment for accurate sample positioning. Inserts for measurement of powders and film/slide samples are included.

Holders on rotational stages, XY stages and electroluminescence sample holders are also available.

X-Ray Sample Chamber

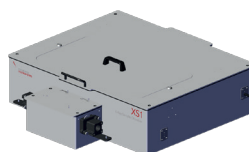

Spectral and time-resolved X-ray excited luminescence are performed in a fibre-coupled sample chamber featuring continuous and/or pulsed X-ray sources. Sample holders for cuvettes, slides and powders are included.

Multi-Well Plate Reader



The FLS1000 can operate multiple position sample holders for user-friendly experimental setup.

This includes the multi-well plate reader for up to 96 well plates. Spectral scanning, lifetime measurements, as well as conventional intensity readings can be made.

Integrating Spheres



The standard integrating sphere allows measurements of absolute quantum yield and reflectance. Accessories are provided for direct and indirect excitation and are available for liquids, powders and films.

A temperature-controlled integrating sphere is also available from 77 K - 500 K.

Cryostat Systems - Open Cycle



Liquid nitrogen and helium cryostats can be fitted to the sample chamber and are fully controlled from the Fluoracle software.

Temperatures from 3 K to 500 K can be achieved depending on the cryostat model.

Cryostat Systems - Closed Cycle



Closed cycle cryostats that do not require large nitrogen or helium reservoirs for operation can be integrated. They are installed on special mounts to reduce vibration, in upright or upside down configuration. These cryostats can be operated from Fluoracle software.

Dewar for Sample Measurements at 77 K



The dewar is a low-cost option for sample measurements at 77 K. The assembly comprises a quartz dewar in a robust mount with clear access to the sample from all four directions.

Remote Measurement Capabilities



Single and bifurcated fibre bundles, FC terminated fibres and liquid light guides can all be coupled to the FLS1000 to enable the use of third-party accessories.

Upright or inverted microscopes can be connected by fibre for widefield excitation. Spectral and/or lifetime measurements can be acquired.

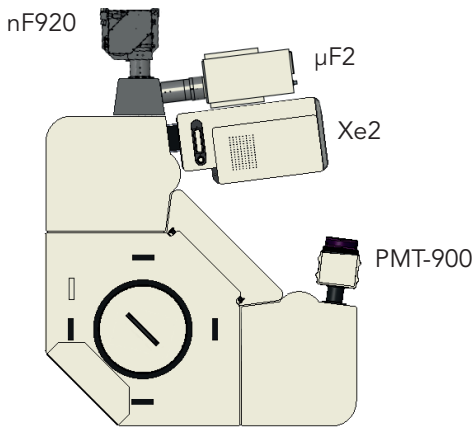

FLS1000-SS – Standard steady state and lifetime (fluorescence and phosphorescence) spectrometer with 450 W xenon lamp, microsecond flashlamp and nanosecond flashlamp.

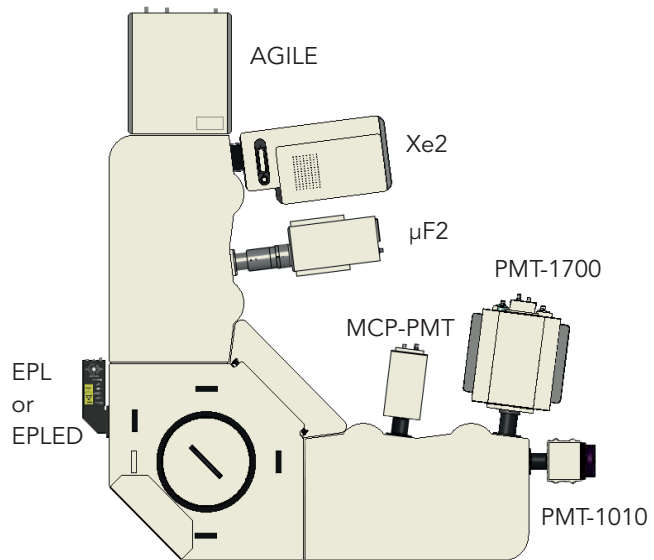

FLS1000-DD – High performance photoluminescence spectrometer with sensitivity up to 1700 nm and pico-second to seconds time resolution capability.

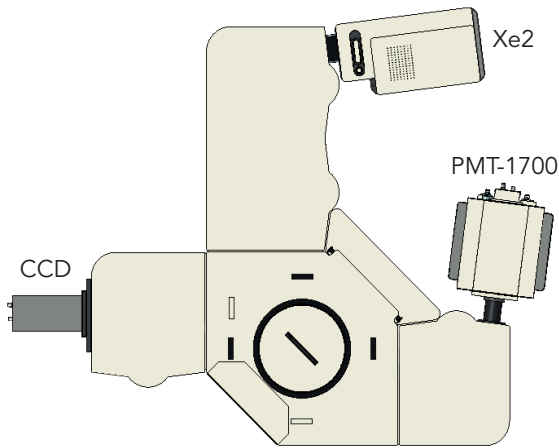

FLS1000-DSS in T-Geometry with CCD camera for recording of VIS-NIR spectra (left emission arm) and PMT for spectral scanning in the near infrared spectral range (right emission arm).

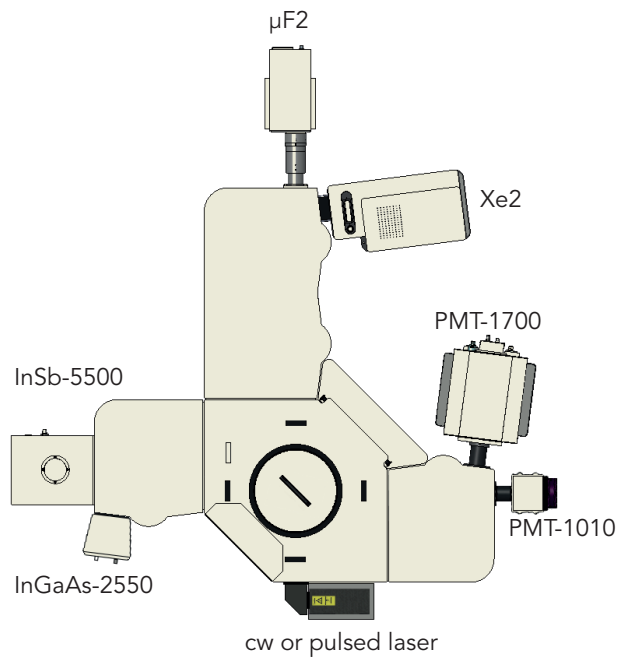

FLS1000-DSS – Spectrometer for steady state and microsecond to second time-resolved luminescence spectroscopy from the visible to the mid-infrared spectral range.

For measurements beyond 1700 nm laser sources (continuous and pulsed) are required for excitation.

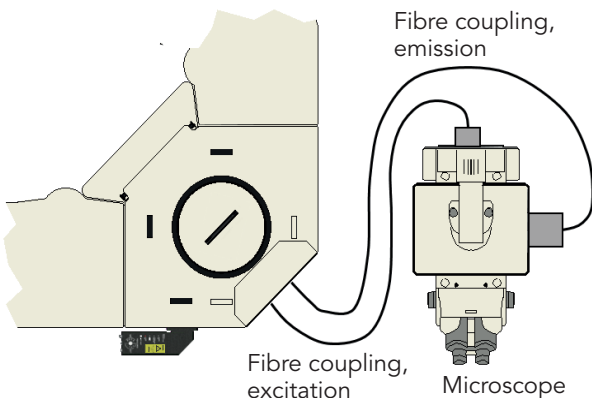

FLS1000 coupled to a microscope. Any variant of the FLS1000 series can be coupled to a microscope by means of the standard fibre coupling. For high spatial resolution the excitation source may be coupled directly to the microscope port.



Some spectrometer configurations include class 3R, 3B or class 4 laser products. Laser safety procedures must be followed.

APPLICATIONS OVERVIEW

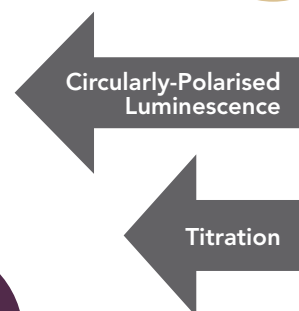
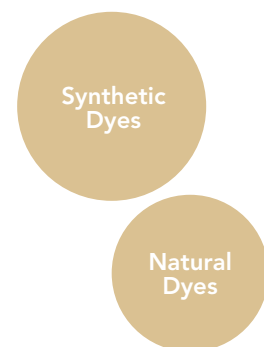
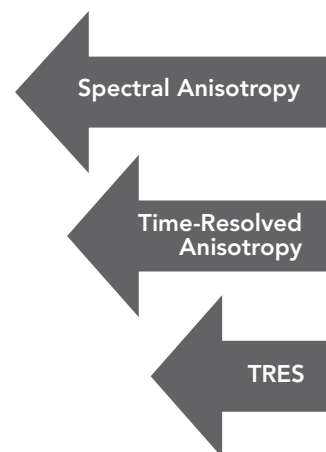
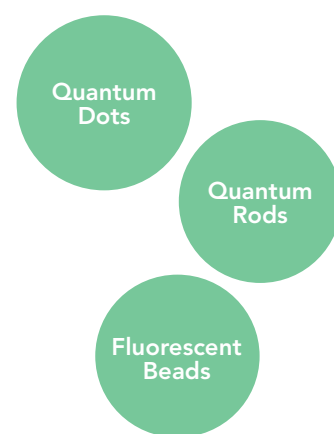
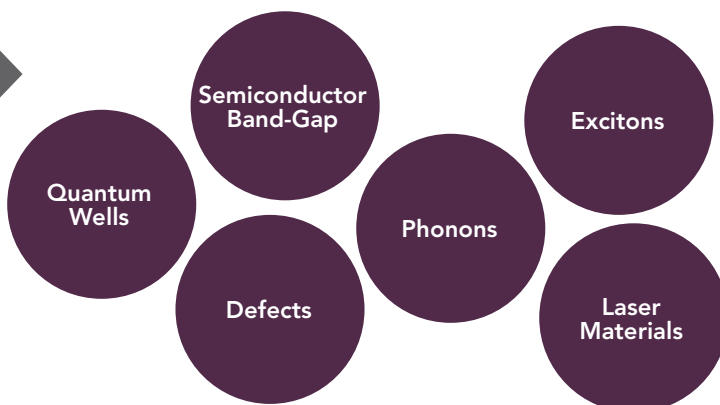
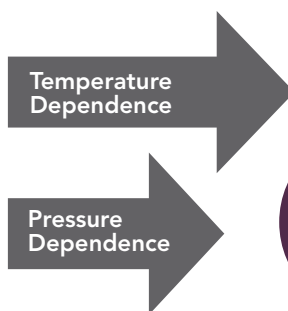
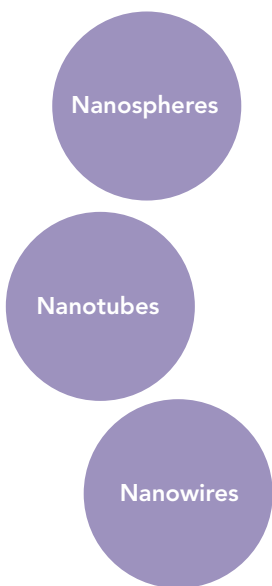
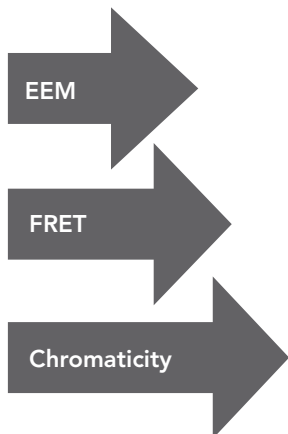
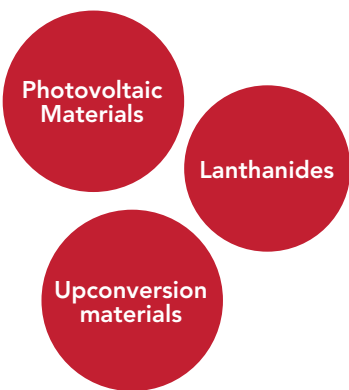

Material Sciences

- Phosphors for the Lighting and Display Industry
- Doped Glasses and Ceramics
- Laser Crystals and Light-Emitting Materials
- Semiconductors Manufacture and Diagnostics
- Materials for Light Harvest, Energy Conversion and Energy Storage
- Fluorescent Inks



Life Sciences

- Fluorescence Based Assays
- Drug Discovery
- Detection of Toxins
- DNA Sequencing
- Research of Molecular Processes and Mechanisms
- Photosensitisers Research
- Singlet Oxygen Detection



Environmental Sciences

- Photo-oxidation of Environmental Pollutants
- Detection of Total Organic Contents
- Detection of Toxic Materials



Forensic Sciences and Security

- Authentication and Identification of Counterfeits
- Detection and Identification of Explosives



Geology

- Identification of Materials by Fluorescence and Phosphorescence
- Age Determination
- Trace Analysis

KEY:

- Technique
- Sample

SYSTEM	
Overall System	Modular, versatile, photoluminescence spectrometer, fully assembled, mounted to baseplate and optically pre-aligned at factory
Sample Chamber	Large sample chamber volume (>40 litres), 5 optical access ports plus 3 access ports for sample handling
Sample Chamber Optics	Lens optics, optional mirror optics
Sample Geometry	Right angle geometry, additional geometries are available to match a large variety of applications
SENSITIVITY	
SNR_{SQRT}	>35,000 : 1 Standard* water Raman Signal-to-Noise Ratio *for definition refer to page 5
Options	Optimisation of sensitivity in Visible and NIR spectral range with optional gratings and detectors
SPECTRAL RANGE	
Excitation	200 nm – 900 nm standard, 115 nm – 2500 nm optional * *source and grating dependent
Emission	200 nm – 900 nm standard, 115 nm – 5500 nm optional ** **detector and grating dependent
LIFETIME RANGES	
Photon Counting	1 ms – hours (spectral acquisitions and kinetic measurements)
MCS	10 ns to 50 s * (phosphorescence lifetime measurements)
TCSPC	5 ps to 10 μs * (fluorescence lifetime measurements) *source and detector dependent
EXCITATION SOURCES	
Continuous Source	Standard Xe2 – xenon arc source
MCS Source	Standard μF2 – xenon flashlamp
TCSPC Sources	VPL / VPLED Series – adjustable pulse width diode lasers and LEDs at discrete wavelengths EPL / EPLED Series – picosecond pulsed diode lasers and LEDs at discrete wavelengths HPL Series – high repetition rate / high power picosecond pulsed diode lasers AGILE – tunable white-light picosecond light source
Options	nF920 – nanosecond flashlamp High power continuous and pulsed lasers available for IR emission and upconversion applications VUV and X-ray excitation available
MONOCHROMATORS	
Type	Symmetrical Czerny-Turner
Focal Length	325 mm, double monochromators: 2 x 325 mm (350 mm available upon request)
Ports	up to 3 entrance and 3 exit ports
Accuracy	± 0.2 nm*
Resolution	0.05 nm
Min Step Size	0.01 nm* * with standard gratings
Option	Spectrographs available for operations of CCDs and Diode array detectors VUV excitation and emission monochromators
DETECTORS	
PMT Detectors	Single Photon Counting Photomultiplier Tubes (PMTs) in cooled housings Standard: PMT-900 Gated Option: PMT-900GT VUV Option: PMT-230 Enhanced spectral response options: PMT-980, PMT-1010, PMT-1400, PMT-1700 Enhanced temporal response options: HS-PMT, MCP-PMT
Analogue Detectors	Semiconductor photodetectors in cooled housings, operated with phase sensitive detection (spectral) or transient digitizer (lifetime)
Array Detectors	InGaAs-1650, InGaAs-2100, InGaAs-2550, InAs-3100, InSb-5500 CCDs, InGaAs array detectors
DATA ACQUISITION	
Model	CB1 TCC2
Modes of Acquisition	Counting/MCS Counting/MCS/TCSPC
Number of det. channels	4 3 (plus 3 Synch channels)
Max. number time bins	8000 8000 (MCS), 8192 (TCSPC)
Min. width of time bins	10 ns 10 ns (MCS), 305 fs (TCSPC)
Time range selection	5 μs – 1000 s 5 μs - 1000 s (MCS), 2.5ns - 50 μs TCSPC)
SOFTWARE	
Fluoracle®	Comprehensive, all-in-one, intuitive software package
Operating System	Windows
Main Functionality	Data acquisition, spectrometer control, graphical display (2D, 3D, contour, colour maps, CIE plots), data operations, data analysis algorithms, measurement and analysis wizards, batch mode measurements, data import/export options
Option	FAST - Advanced lifetime data analysis add-on, including up to 200 lifetime distributions, stretched exponentials, global analysis, advanced error analysis, micellar quenching, Förster kinetics, advanced time-resolved fluorescence anisotropy analysis

EDINBURGH INSTRUMENTS

2 Bain Square,
Kirkton Campus,
Livingston, EH54 7DQ
United Kingdom

Tel: +44 (0)1506 425 300
Fax: +44 (0)1506 425 320

sales@edinst.com

U.S. OFFICE CONTACT:

Tel: +1 800 323 6115
Fax: +44 (0)1506 425 320

ussales@edinst.com



Customer support is
available worldwide

[edinst.com](https://www.edinst.com)

Registered in England and Wales No: 962331 VAT No:GB 271 7379 37
©Edinburgh Instruments Ltd 2022

Stage 03 / 04.2022

